

 HYGCEL research presentation

Resource potentials and regional imbalances in infrastructure development

Lappeenranta, May 22, 2024

Presentations in this session

1. Finland's distributed PtX resources create unique production locations
 - Hannu Karjunen, post-doctoral researcher, LUT University
2. Finland's distributed resources create regional energy imbalances and transportation needs
 - Sami Repo, professor, Tampere University
3. Value from PtX plant flexibility
 - Tero Tynjälä, professor, LUT University

Finland's distributed PtX resources create unique production locations

Topics of this presentation

- Finland's wind and solar potential and its distribution
- Distributed resources affecting infrastructure development

Contributors:

Jukka Lassila, LUT University

Hannu Karjunen, LUT University

Markus Salmelin, LUT University

Otto-Eeti Räisänen, LUT University

Finland could supply 10% of EU's renewable electricity

- EU electricity demand ~3700 TWh by 2030, including hydrogen demand of 10 Mt_{H₂} (530 TWh_{el})
- Available renewable potential exceeds Finland's domestic energy needs → export strategy needed
- Finland's renewable power supply will be determined by social acceptance, demand and techno-economics
- Production sites for wind and solar complement each other

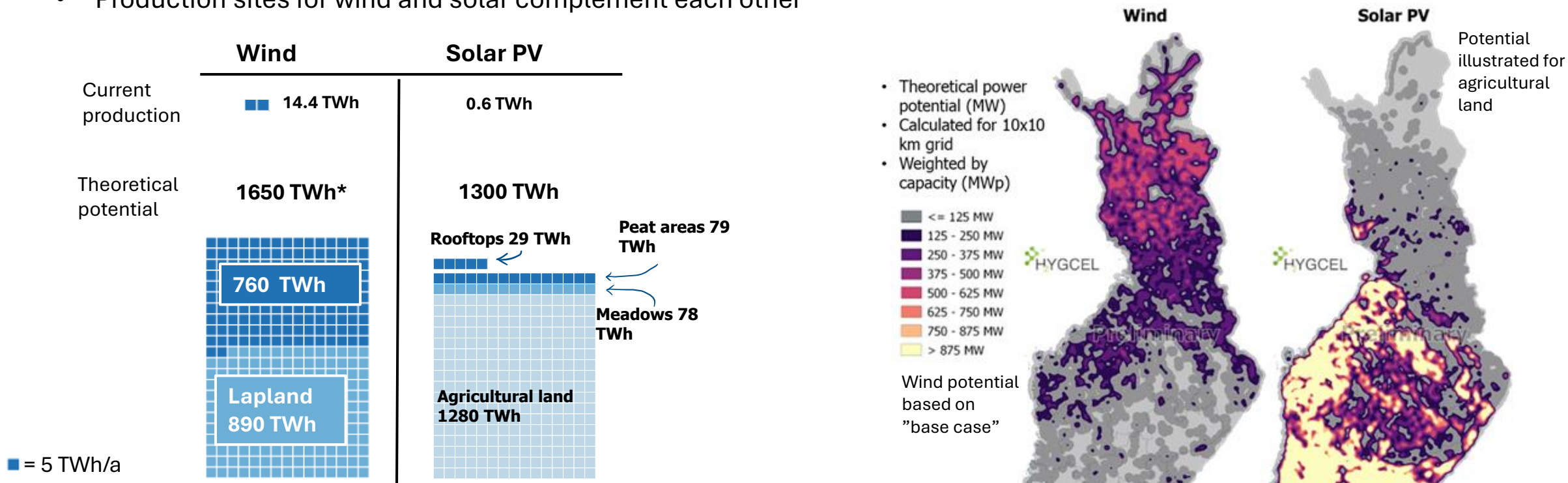

* based on our "base case"-scenario land-use assumptions (potential in scenarios varied between 700 – 2500 TWh)

PtX is sensitive to local conditions

- Each location is unique: different constraints and opportunities
- Location and design of an PtX industrial cluster will depend on several factors, like the availability of renewable power or CO₂
 - Customized solutions for power supply, hydrogen storages and heat
 - Small production volumes are easier to place
- RFNBO regulation concerning connection requirements will be in a decisive role

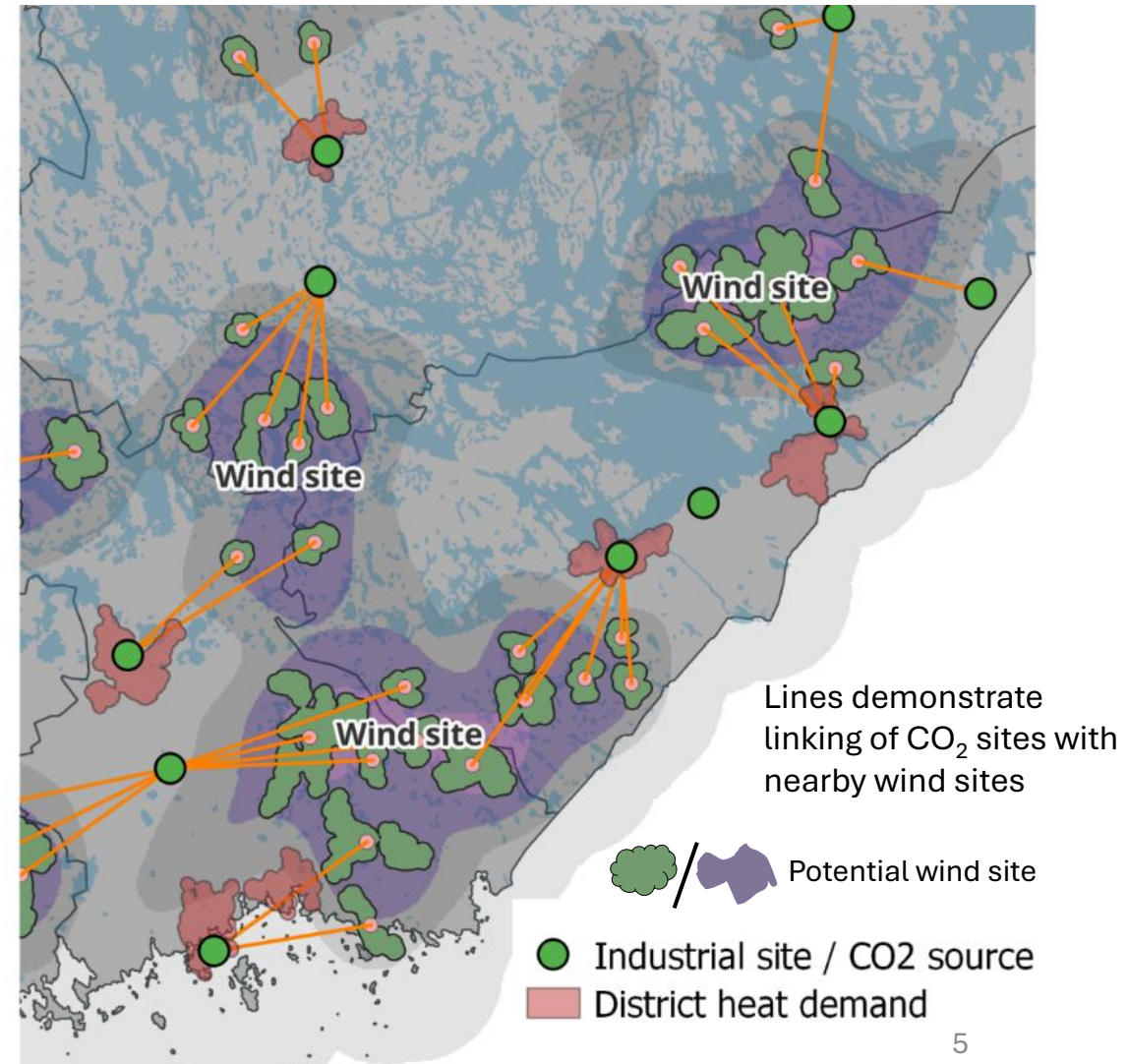

There are several ways to connect the resources

- Renewable power generation capacity is spread across large areas and unevenly
- A demonstration (orange lines in the figure) was made to connect wind sites and CO₂ point sources.
 - Regions of surplus and deficit areas are formed
 - Transport infrastructure is needed
 - Resources might need to be connected from far
- Time window is open for deciding the placement of industrial clusters:
 - National strategies needed to guide the development?

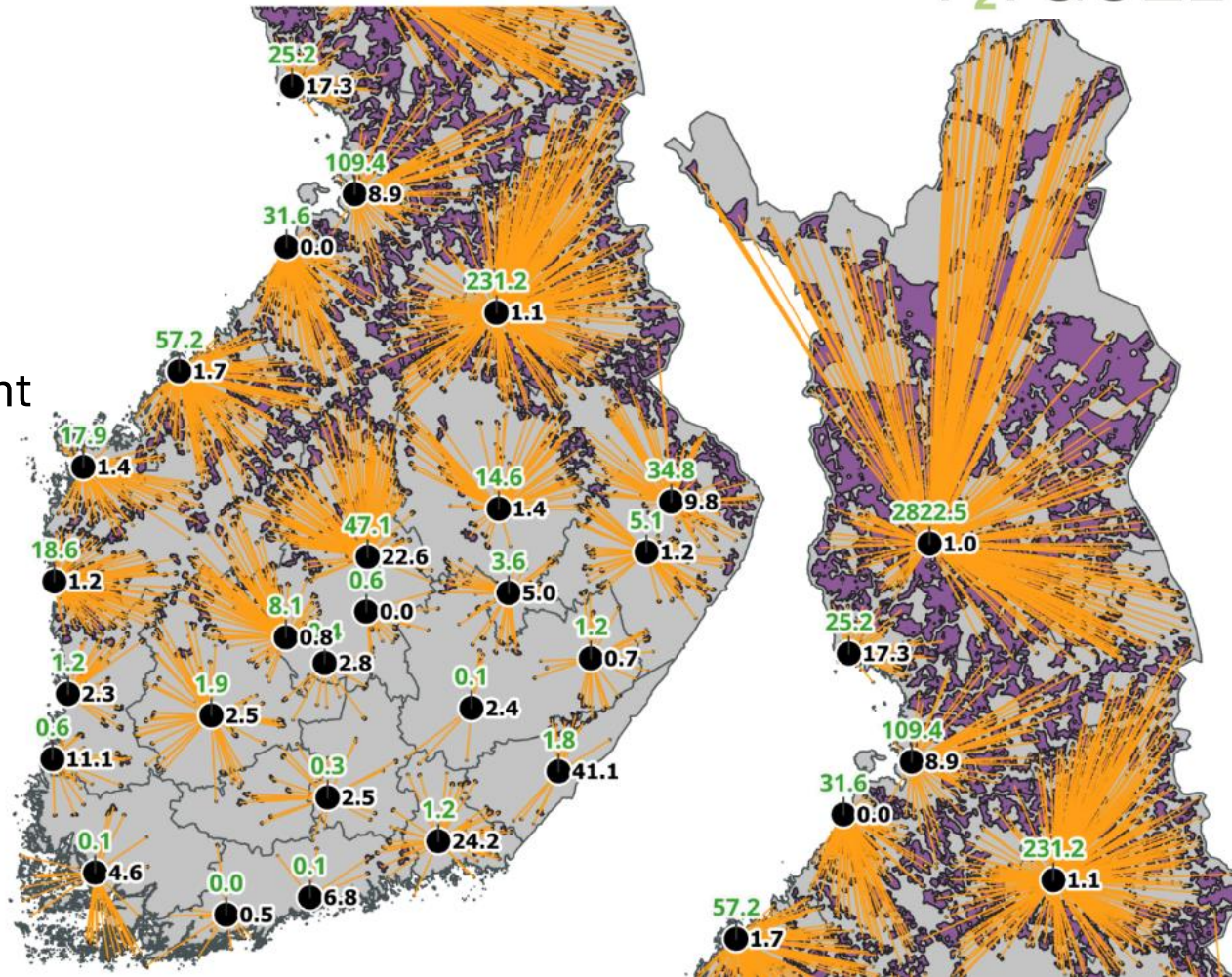
The logo for HYGCEL, featuring a stylized green and yellow molecular structure to the left of the text "HYGCEL" in a bold, sans-serif font.

Green: Wind potential (TWh)

Black: CO₂ conversion electricity demand (TWh)

Finland's distributed PtX resources create unique production locations

Key messages

- Renewable power potential is significant, dimensions of sustainability
- Wind and solar resources provide balancing of regional differences
- Wind and solar resources provide temporal balancing
- Local resources are always different, requiring tailored solutions
- Transport of resources will be required, in one form or another

Finland's distributed resources create regional energy imbalances and transportation needs

Topics of this presentation

- Distributed nature of resources and locational imbalances
- Energy transportation needs across areas of Finland.

Contributors:

Yrjö Majanne, Tampere University

Venla Vilhonen, Tampere University

Arttu Virtanen, Tampere University

Sami Repo, Tampere University

Matti Vilkkö, Tampere University

An energy system model of Finland was developed to study future energy needs

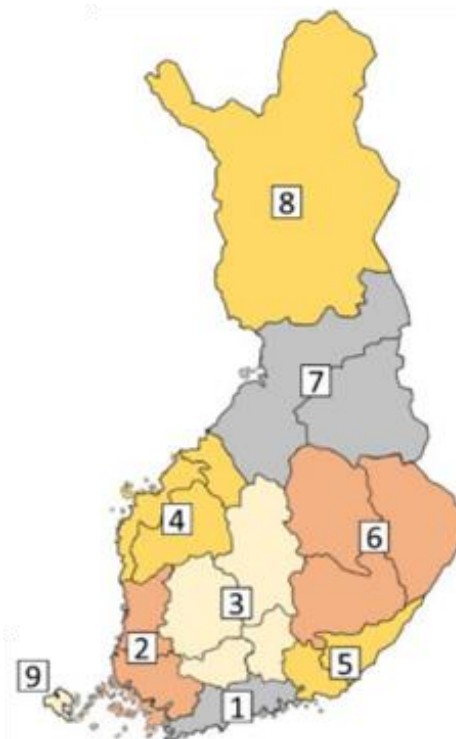
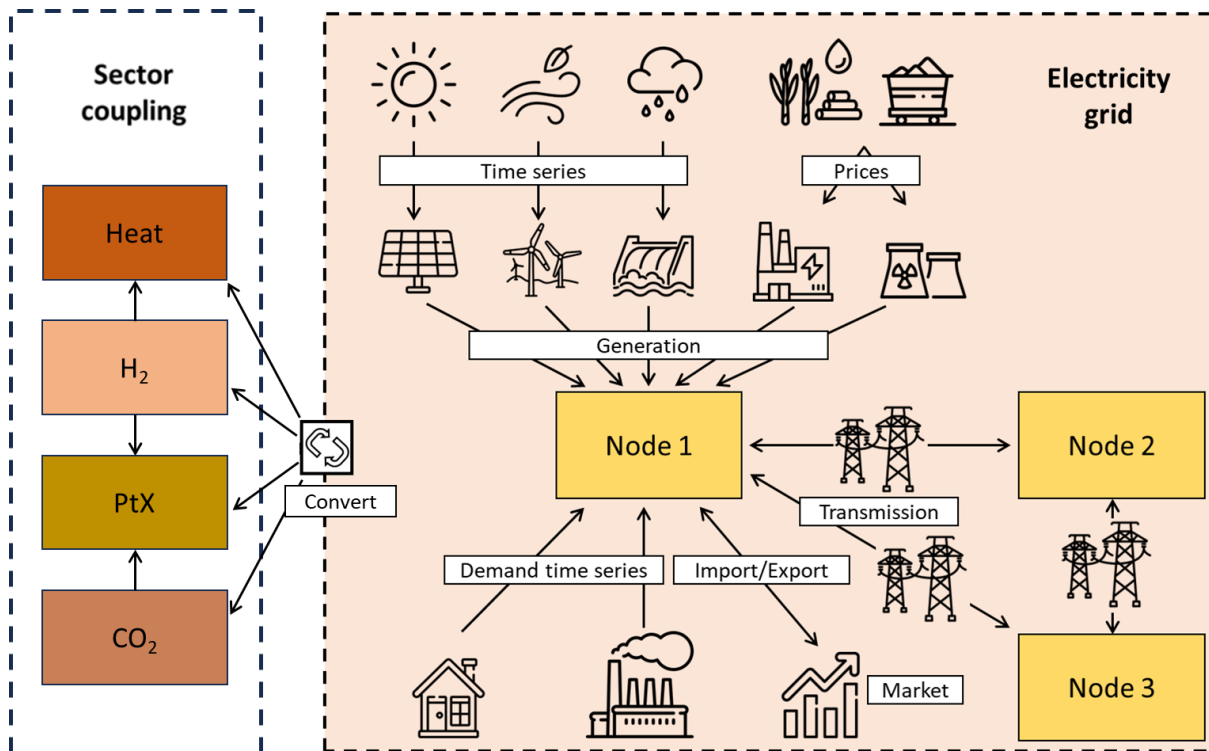

- Mathematical model representing the regional structure and operation of the energy system in Finland.
- In the model, Finland is divided into 9 regions.
- The model optimizes the cheapest way to produce the hourly energy demand. Storages and demand response is included.

Three scenarios were modelled

- **Business as usual (BAU 2035)**
 - Finland's energy infrastructure develops by assuming the current publicly announced PtX development and extrapolating that to 2035.
- **Self-sufficiency (SS 2035 and SS 2050)**
 - All the consumed energy is produced in Finland
- **Maximal utilization (MU 2050)**
 - All the consumed energy is produced in Finland
 - Excess electricity is used for manufacturing PtX products for export

Electricity production capacities (left) and yearly production (right) in different scenarios

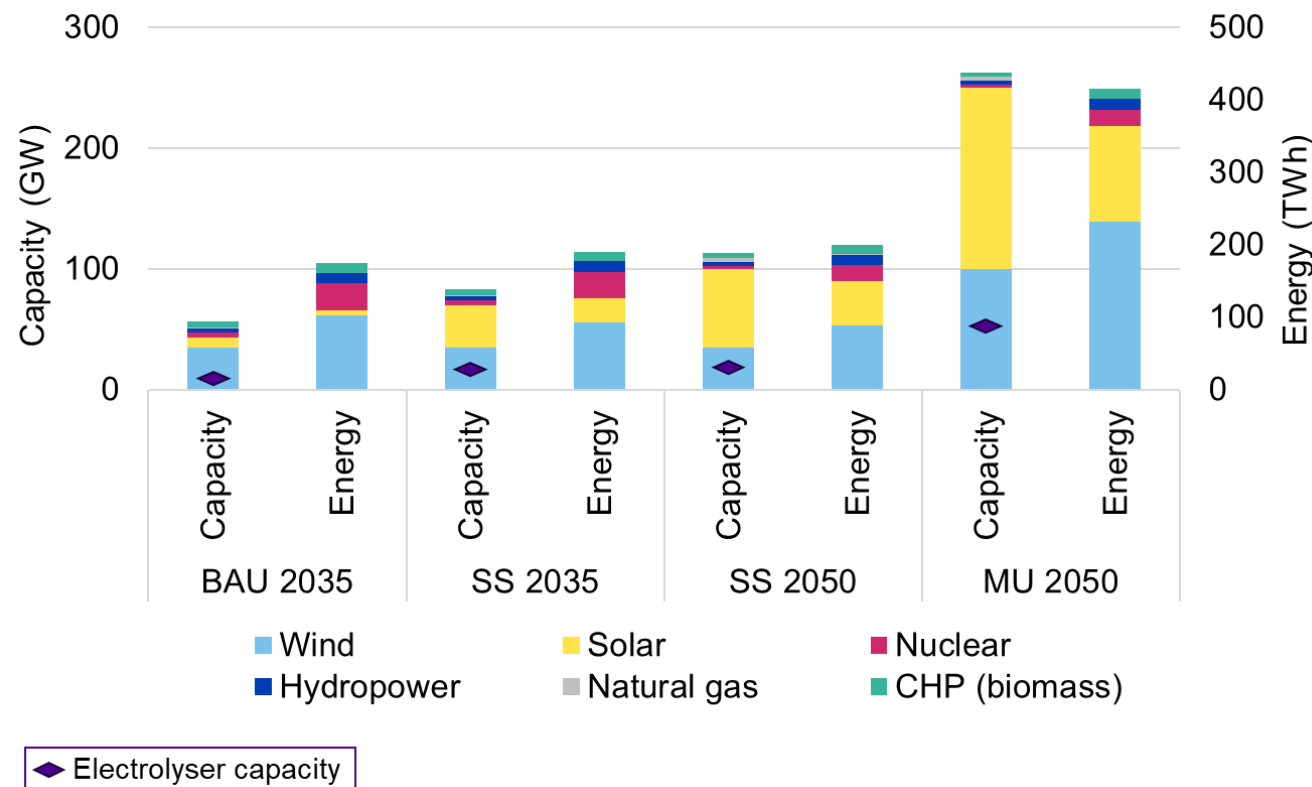

Modelling reveals regional imbalances

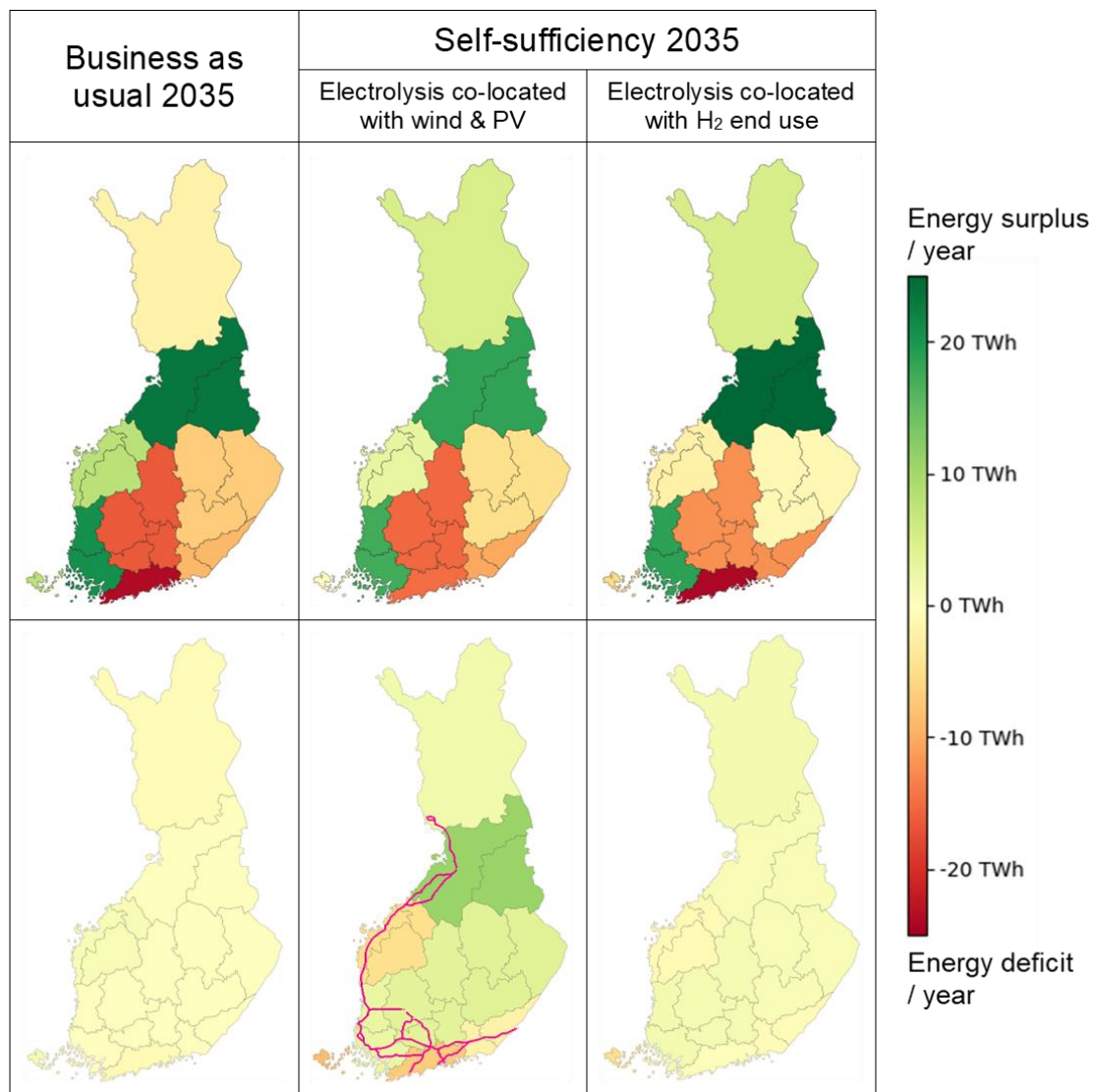

- The distributed nature of renewable energy resources and energy demand leads to regional imbalances: Finland has significant energy surplus and energy deficit areas.
- Modelled locations of production units (wind, PV, electrolysis, PtX) influence energy transport needs from one area to another
- Electricity grid reinforcement needs can be reduced by implementing a hydrogen transport infrastructure
 - This applies if electrolysis is regionally co-located with renewable electricity production

Flexibility needed in the value chain

- The energy system needs flexible loads (i.e., flexible consumption) to balance the high variability of renewable electricity production
- To utilize all variable green electricity production potential, hydrogen production must be flexible and **buffered with storages**.
- Insufficient buffer storage capacity reduces hydrogen production volumes (i.e., potential will be lost).
- The energy system needs buffer storage capacity to cope with the temporal variations of green electricity production and this will not depend on the locations of hydrogen production units.

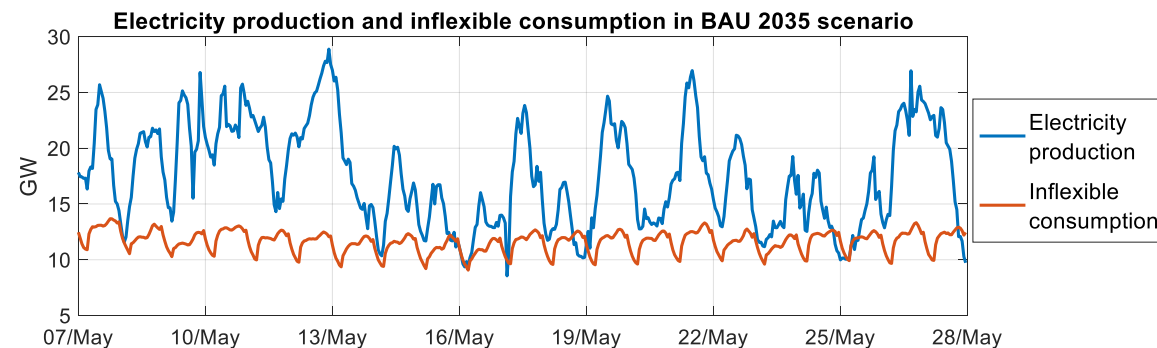

Electricity production

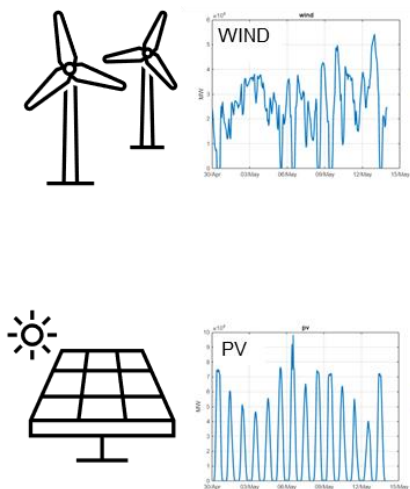

Hydrogen production

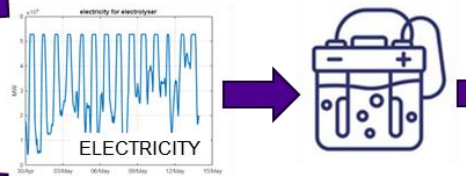

Other flexible loads

Hydrogen grid & storages

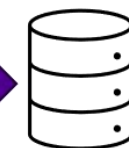

Synthetic fuel production, industrial use of H₂

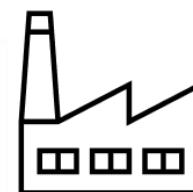
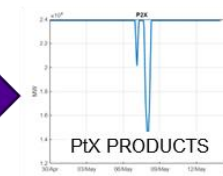

Finland's distributed resources create regional energy imbalances and transportation needs

Key messages

- Distributed nature of resources means that Finland has significant energy surplus and energy deficit areas.
- Electricity grid reinforcement needs can be reduced by implementing a hydrogen transport infrastructure
 - This applies especially if electrolysis is co-located with renewable electricity production.
- System level storage capacity and flexible electrolysis are needed in all scenarios, and it is not dependent on how hydrogen production will be located.

Value from PtX plant flexibility

Topics of this presentation

- Flexibility in as a requirement from the system level to the production plant level
- Results from a dynamic methanol production simulation case study
- Results from H₂ storage studies

Contributors:

Arto Laari, LUT University

Hung Nguyen, LUT University

Tero Tynjälä, LUT University

Eero Inkeri, LUT University

Sampo Vilve, LUT University

Jaakko Hyypiä, LUT University

Hossein Enayatizadeh, LUT University

Pedro Juliano Nardelli, LUT University

Mehar Ullah, LUT University

Daniel Gutierrez Rojas, LUT University

Gustavo de Almeida, LUT University

PtX production plants create value

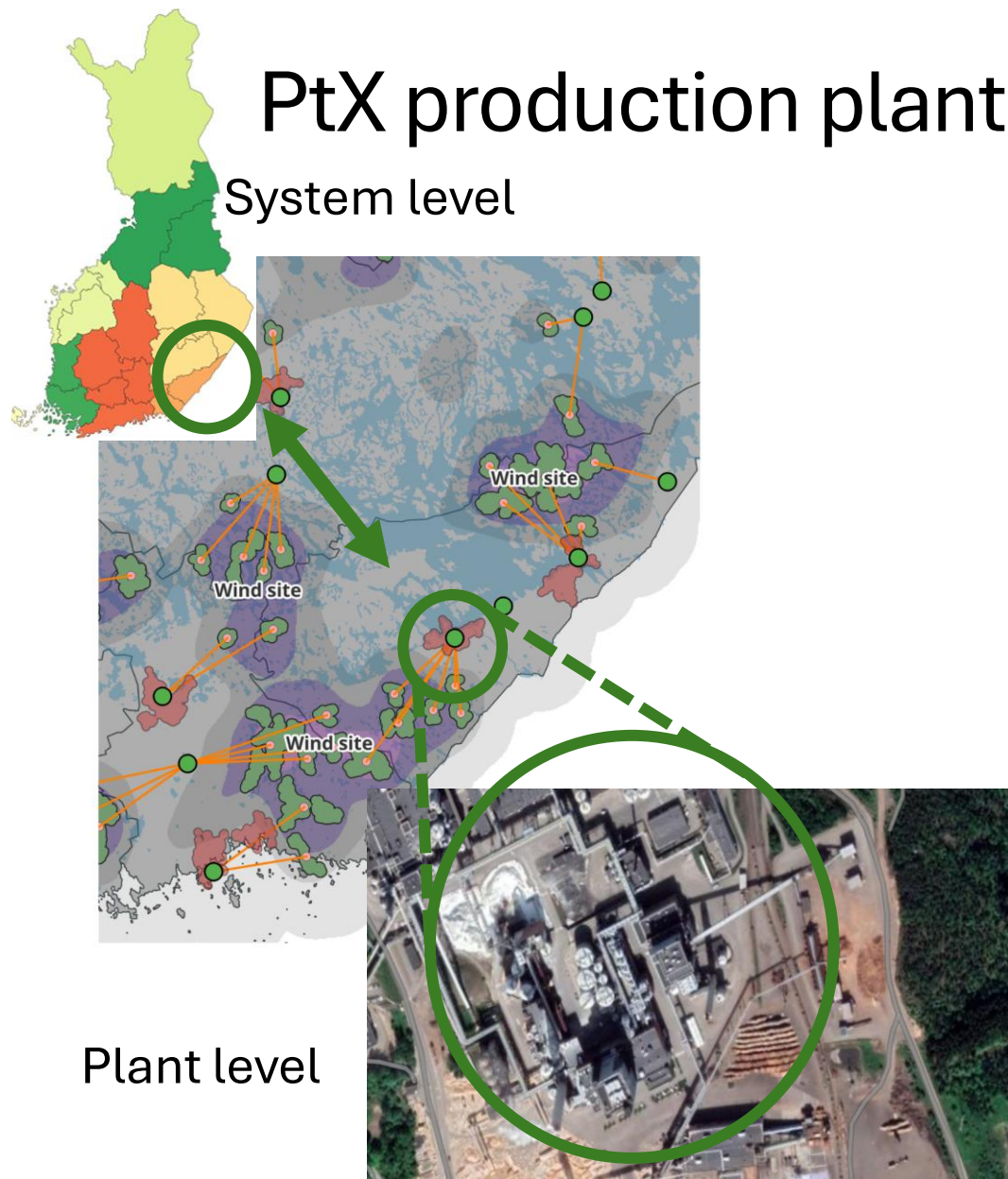

- Distributed renewable electricity –based energy system is regionally and temporally imbalanced
- Flexibility is needed both at the system level and at plant levels
- Flexibility at plant levels provide both stability and added value
- Plant level flexibility is provided by:
 - Storages for H₂, CO₂, heat, and final products
 - Electrolysis, synthesis, CO₂ capture processes

Results from simulation studies: Methanol processes can be modified to provide more flexibility and value

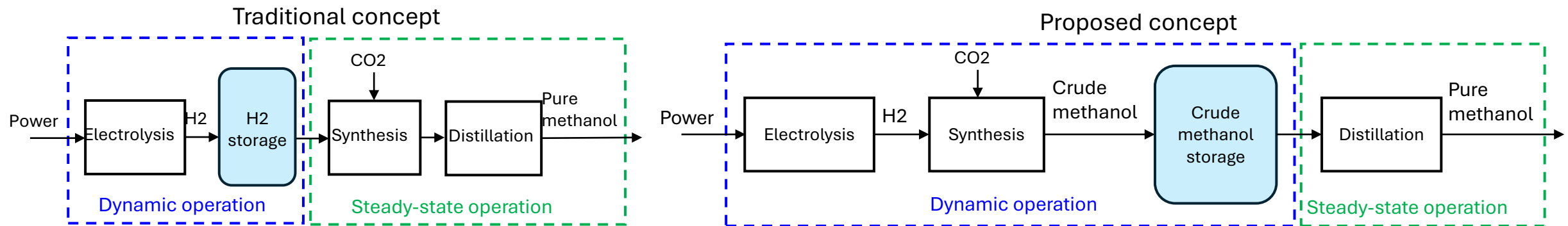

- Traditionally synthesis units and distillation processes are directly coupled
- Decoupling the process into dynamic production and steady state purification provides:
 - Shorter process start-up time
 - Faster process load changes, lower minimum load level
 - Storing of crude methanol is cheaper than storing of hydrogen

Findings related to hydrogen storages

- Optimal H₂ storage capacity varies between years and used electricity mix (Fig.1)
- H₂ tank storage cost increases H₂ production costs by 0.1-0.8 €/kg_{H2} (Fig. 2)
- Cost assumptions have a large effect on optimal unit capacities and full load hours

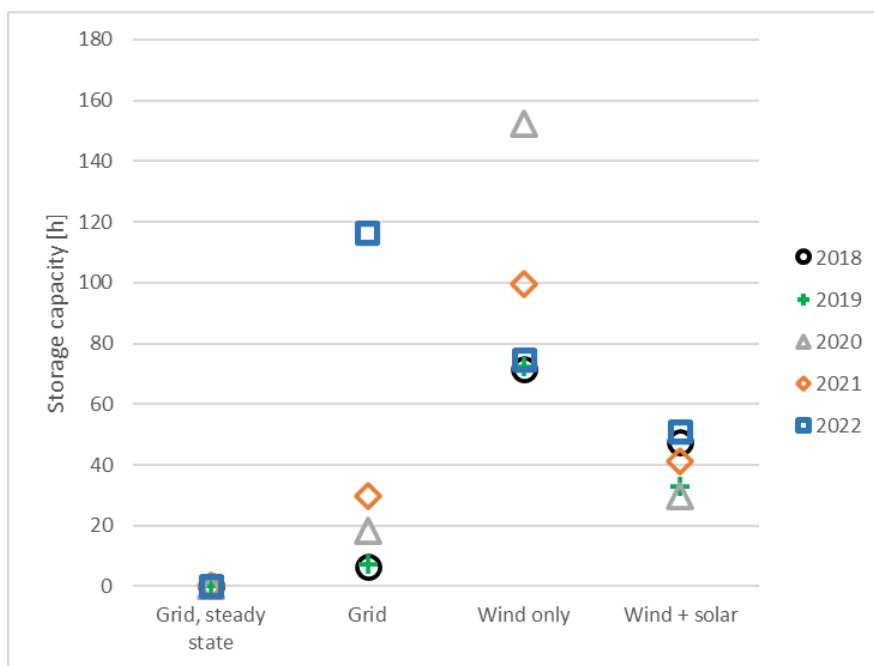

Source: Hyypiä, J. et al. (2023) HYGCEL results page
<https://www.lut.fi/en/hygcel>

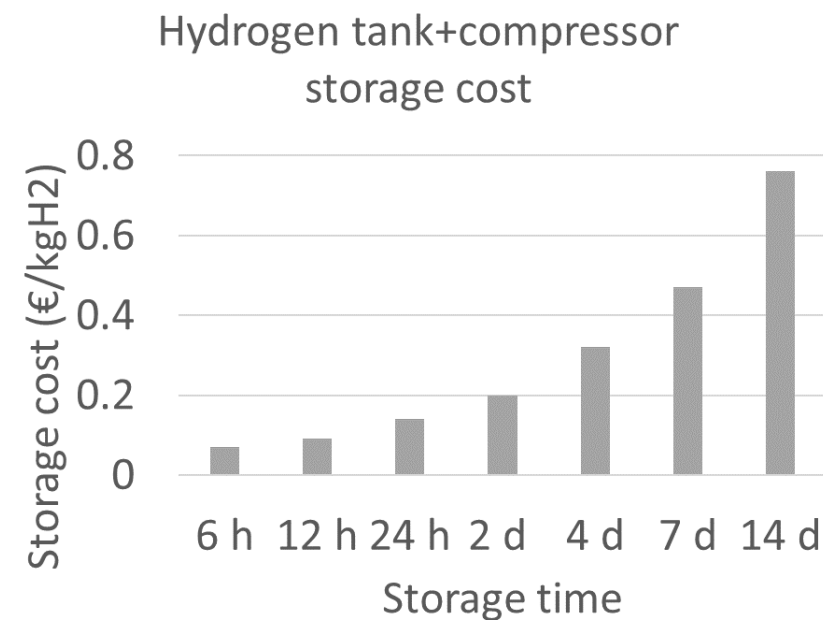

Source: Vilve, Sampo (2023). HYGCEL results page
<https://www.lut.fi/en/hygcel>

AI and IoT in PtX operations

- AI and machine learning based solutions can provide efficient ways to simulate and forecast plant operation.
- Current practices doesn't support collecting storing and sharing big data between multiple actors.
- Industrial interfaces need development, standardization and new policies to guarantee secure and reliable data sharing.

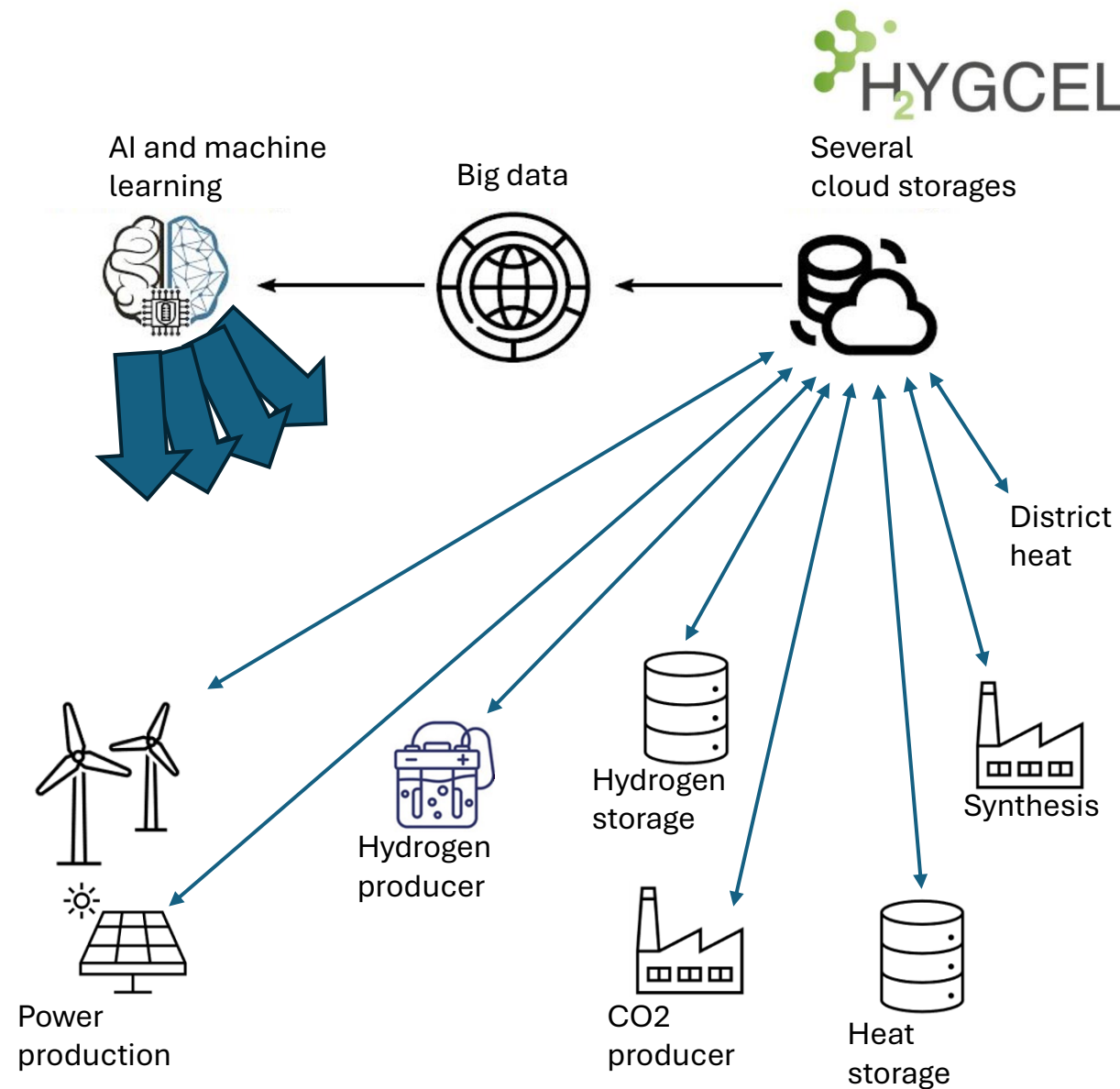

Value from PtX plant level flexibility

Key messages

- Plant level flexibility provides added value for PtX plant operator.
- Optimal dimensioning of storages and process components is highly dependent on used electricity mix (wind, solar, grid) and operation conditions, such as annual price variations of electricity, heat and PtX products.
- Operation optimization can benefit from AI-based tools and data sharing IoT platforms.